

**FEATURES**

- \* SPECIAL FOR HIGH CURRENT AND LOW FORWARD VOLTAGE
- \* HIGH POWER
- \* AVAILABLE FOR PULSE OPERATING
- \* WIDE VIEWING ANGLE
- \* BLUE TRANSPARENT COLOR PACKAGE
- \* AMMO PACK
- \* TIN DIPPING LEADS

**PACKAGE DIMENSIONS****NOTES:**

1. All dimensions are in millimeters (inches).
2. Tolerance is  $\pm 0.25\text{mm}$  (.010") unless otherwise noted.
3. Protruded resin under flange is 1.5mm (.059") max.
4. Lead spacing is measured where the leads emerge from the package.
5. Specifications are subject to change without notice.

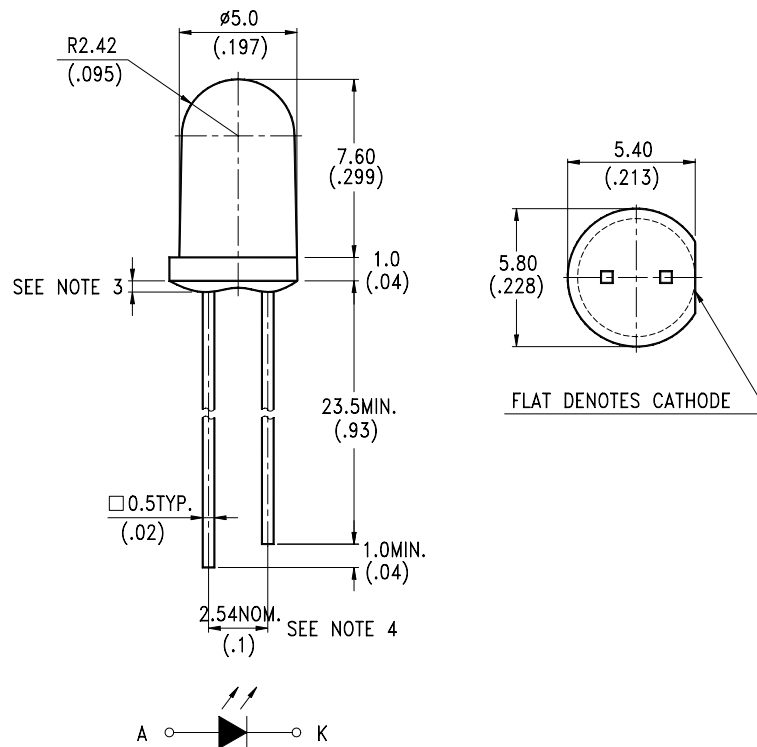

# LITE-ON TECHNOLOGY CORPORATION.

Property of Lite-On Only

## ABSOLUTE MAXIMUM RATINGS AT TA=25

PARAMETER	MAXIMUM RATING	UNIT
Power Dissipation	150	mW
Peak Forward Current (300pps, 10 $\mu$ s pulse)	2	A
Continuous Forward Current	100	mA
Reverse Voltage	5	V
Operating Temperature Range	-40 to + 85	
Storage Temperature Range	-55 to + 100	
Lead Soldering Temperature [1.6mm(.063") From Body]	260 for 5 Seconds	

## ELECTRICAL OPTICAL CHARACTERISTICS AT TA=25

PARAMETER	SYMBOL	MIN.	TYP.	MAX.	UNIT	TEST CONDITION	BIN GRADE
Radiant Intensity	I <sub>E</sub>	30			mW/sr	I <sub>F</sub> = 100mA	BIN B
		44			mW/sr	I <sub>F</sub> = 100mA	BIN C
		52			mW/sr	I <sub>F</sub> = 100mA	BIN D
		62			mW/sr	I <sub>F</sub> = 100mA	BIN E
Peak Emission Wavelength	$\lambda$		940		nm	I <sub>F</sub> = 20mA	
Spectral Line Half-Width			50		nm	I <sub>F</sub> = 20mA	
Forward Voltage	V <sub>F</sub>		1.25	1.6	V	I <sub>F</sub> = 50mA	
Forward Voltage	V <sub>F</sub>		1.85	2.3	V	I <sub>F</sub> = 500mA	
Reverse Current	I <sub>R</sub>			100	$\mu$ A	V <sub>R</sub> = 5V	
Viewing Angle (See FIG.6)	2 1/2		50		deg.		

## TYPICAL ELECTRICAL / OPTICAL CHARACTERISTICS CURVES

(25 Ambient Temperature Unless Otherwise Noted)

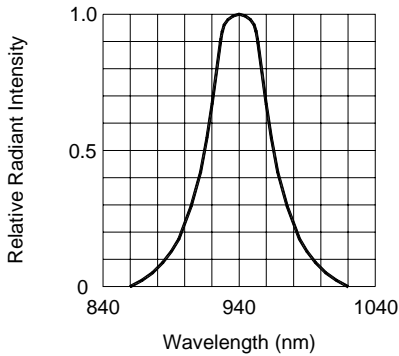

FIG.1 SPECTRAL DISTRIBUTION

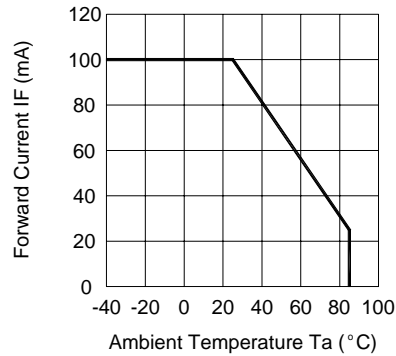

FIG.2 FORWARD CURRENT VS. AMBIENT TEMPERATURE

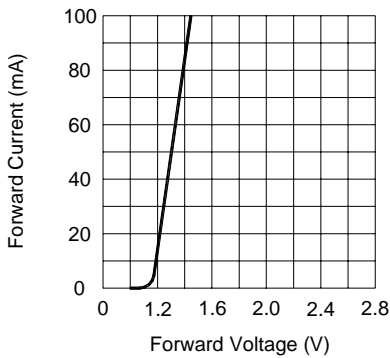

FIG.3 FORWARD CURRENT VS. FORWARD VOLTAGE

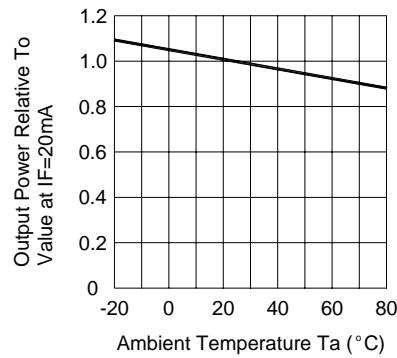

FIG.4 RELATIVE RADIANT INTENSITY VS. AMBIENT TEMPERATURE

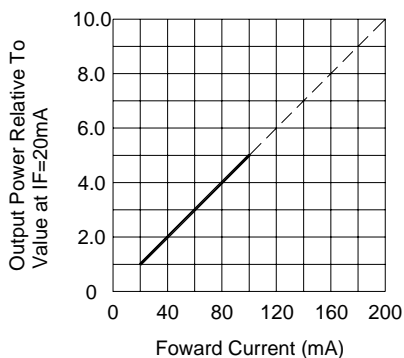

FIG.5 RELATIVE RADIANT INTENSITY VS. FORWARD CURRENT

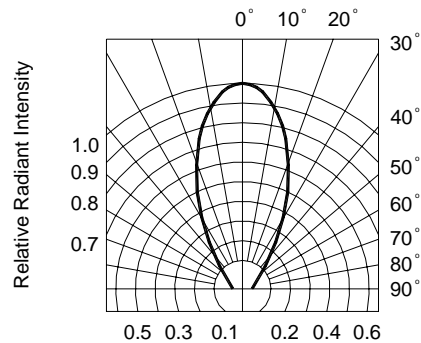

FIG.6 RADIATION DIAGRAM