

Shuen Series

炫

“Shuen [Xuan] is the English translation for the Chinese word meaning Bright and Shiny. Both words are relevant descriptions of this Everlight LED series. The modern, adaptive Chinese definition of the word represents that which is New, Extravagant, and Highly Sought After.”

Introduction

The Shuen series is a surface-mount high-power device featuring high brightness combined with a compact size that is suitable for all kinds of lighting applications such as general illumination, flash, spot, signal, industrial and commercial lighting. The thermal pad of this device is electrically isolated providing convenience in thermal and electrical design. The Shuen series is one of the most promising devices in Everlight’s high power product offering and is ready to face the challenges of today’s Solid-State Lighting requirements.

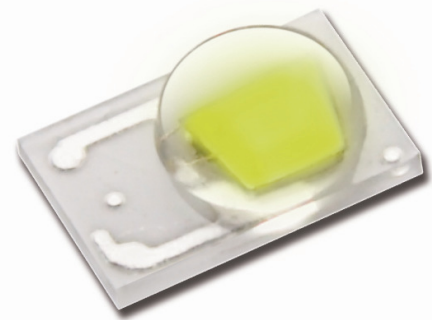

Features

- ◆ Small package with high efficiency
- ◆ ESD protection up to 8KV
- ◆ Soldering method: SMT
- ◆ Binning Parameters: Brightness, Forward Voltage, Wavelength and Chromaticity
- ◆ Moisture Sensitivity Level: 1
- ◆ RoHS compliant
- ◆ Matches ANSI binning
- ◆ Reliability testing conforms to IESNA LM80 Lumen maintenance test method
- ◆ Electrically isolated thermal pad

Applications

- ◆ General Lighting
- ◆ Decorative and Entertainment Lighting
- ◆ Signal and Symbol Luminaries for orientation marker lights (e.g. steps, exit ways, etc.)
- ◆ Exterior and Interior Automotive Illumination

Table of Contents

Product Nomenclature	3
Luminous Flux Characteristics for the Shuen series	4
Flux Performance, Binning, and Supportability	5
PN of the Shuen series: White LEDs	6
PN of the Shuen series: Color LEDs	7
Average Lumen Maintenance Characteristics	8
Environmental Compliance	8
Product Binning	9
White Bin Structure	10
Forward Voltage Bins	14
Color Bins	15
Optical Characteristics	16
Absolute Maximum Ratings	17
JEDEC Moisture Sensitivity	17
Mechanical Dimension	18
Pad Configuration	19
Reflow Soldering Characteristics	20
Wavelength Characteristics	21
Typical Light Output Characteristic vs. Thermal Pad Temperature	23
Typical Electrical Characteristics	24
Typical Relative Luminous Flux vs. Forward Current	25
Typical Wavelength & CCT Shift Characteristics vs. Forward Current	27
Current Derating Curves	29
Typical Radiation Patterns	30
Emitter Tape Packaging	32
Emitter Reel Packaging	33
Product Labeling	33
Revision History	34

Product Nomenclature

The product name is designated as below:
 ELSH – ABCDE – FGHIJ – V1234

Designation:

- AB = min. luminous flux (lm) or radiation power (mW) performance
- C = radiation pattern ^[1]
- D = color ^[2]
- E = power consumption ^[3]
- F = reserved for future product offerings
- G = chip source ^[4]
- H = packaging type ^[5]
- IJ = internal coding
- V = forward voltage bin
- 1234 = color bin or CCT bin

Notes

1. Table of radiation patterns

Symbol	Description
1	Lambertian
0	No lens

2. Table of color offerings:

Symbol	Color	Dominant wavelength range
R	Red	620~635nm
O	Orange	610~620nm
Y	Amber	580~595nm
G	Green	520~550nm
B	Blue	450~470nm
C	Cool-White	4745~7050K
N	Neutral-White	3710~4745K
M	Warm-White	2580~3710K
L	Royal-Blue	430~450nm
E	Deep-Red	650~670nm
A	Cyan	490~520nm

3. Table of power consumptions:

Symbol	Description
1	1W
2	0.3W
3	3W
4	0.5W
5	5W
6	10W
7	15W
8	20W

4. Table of chip sources:

Symbol	Description
L	Others
C	High Request

5. Table of packaging types:

Symbol	Description
P	Tape
B	Tube

Luminous Flux Characteristics for the Shuen series

Color	Part Number	1W		3W	
		Minimum Luminous Flux(lm) or Radiometric Power(mW) ^[1]	Drive Current (mA)	Minimum Luminous Flux(lm) or Radiometric Power(mW) ^[1]	Drive Current (mA)
Cool White	ELSH – F71CX	70	350	---	700
	ELSH – F81CX	80	350	---	700
	*ELSH – F91CX	90	350	---	700
	*ELSH – J11CX	100	350	---	700
Neutral White	ELSH – F71NX	70	350	---	700
	ELSH – F81NX	80	350	---	700
	*ELSH – F91NX	90	350	---	700
	*ELSH – J11NX	100	350	---	700
Warm White	ELSH – F41MX	45	350	---	700
	ELSH – F51MX	52	350	---	700
	ELSH – F61MX	60	350	---	700
	*ELSH – F71MX	70	350	---	700
Red	ELSH – F31RX	39	350	---	700
	ELSH – F41RX	45	350	---	700
	ELSH – F51RX	52	350	---	700
	*ELSH – F61RX	60	350	---	700
Orange	ELSH – F31OX	39	350	---	700
	ELSH – F41OX	45	350	---	700
	ELSH – F51OX	52	350	---	700
	*ELSH – F61OX	60	350	---	700
Amber	ELSH – F31YX	39	350	---	700
	ELSH – F41YX	45	350	---	700
	ELSH – F51YX	52	350	---	700
	*ELSH – F61YX	60	350	---	700
Green	ELSH – F71GX	70	350	---	700
	ELSH – F81GX	80	350	---	700
	*ELSH – F91GX	90	350	---	700
Blue	ELSH – E61BX	13	350	---	700
	ELSH – E71BX	17	350	---	700
	*ELSH – E81BX	20	350	---	700
Deep Red	ELSH – Q91EX	275	350	---	700
	*ELSH – R11EX	350	350	---	700
Royal Blue	ELSH – Q81LX	225	350	---	700
	*ELSH – R11LX	350	350	---	700
Cyan	*ELSH – F31AX	39	350	---	700
	*ELSH – F51AX	52	350	---	700

Note:

1. Luminous flux measurement tolerance: ±10%.
2. The data of luminous flux measured at thermal pad=25°C
3. Typical luminous flux or light output performance is operated within the condition guided by this datasheet.
4. Please contact sales for timing and availability of 3W products and P/N's marked with an asterisk "**".

Flux Performance, Binning, and Supportability

Developing LEDs requires a strict process flow beginning at the wafer level, passing through standard semiconductor SOP, and finally ending up with die in package. Most binning specifications are determined by performance of the EPI-wafer. Everlight LED binning is based upon the results of these die as well as the professionalism and ingenuity of Everlight packaging. Proper blueprinting of Everlight production distribution allows customers to choose readily available bins that fulfill their requirements.

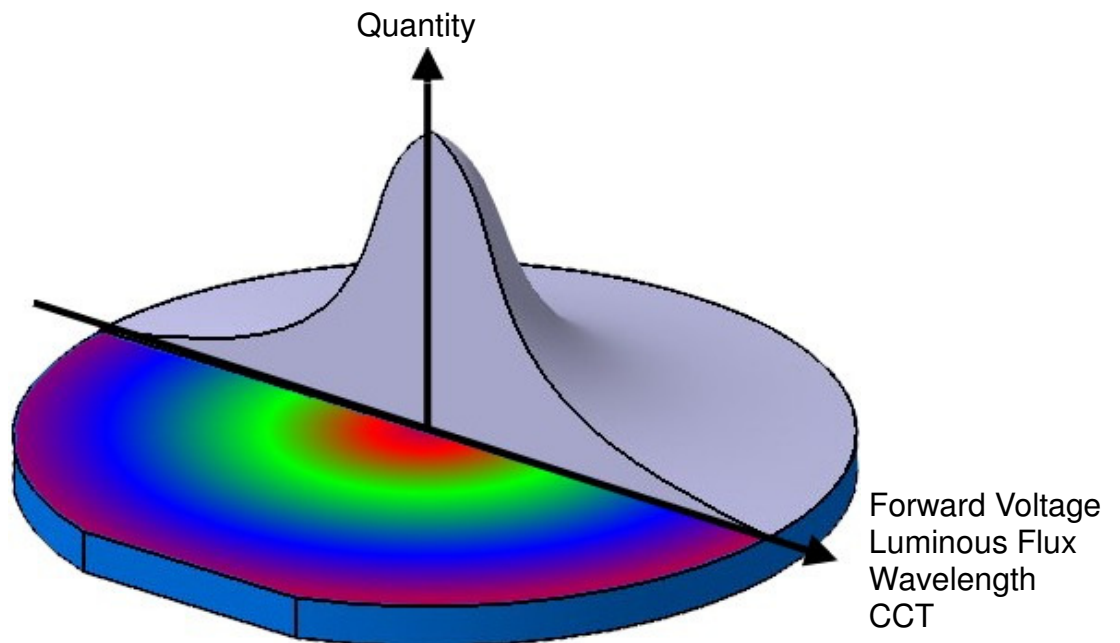

PN of the Shuen series: White LEDs

The below table lists of part numbers for the Everlight Shuen series White LED. All parts listed match ANSI binning standards. Bin offerings of 5700K,6500K,and 3000K are listed and currently available. CRI is also listed with variations from typical 70 to 90. These clearly listed binning options allow for proper design and implementation into lighting applications.

For Example: If you order product using P/N **ELSH-F81C1-0LPES-C5700**, you will get

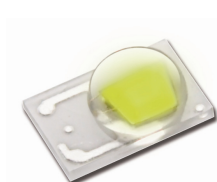

Color Variant	Radiation Pattern	CRI	CCT	Forward Voltage (V)	Minimum Luminous Flux (lm)
Cool White	Lambertian	80	57K-1 ~ 57K-2 ~ 57K-3 ~ 57K-4	2.95~3.25(V1) 3.25~3.55(V2) 3.55~3.85(V3)	80

White, Shuen series LEDs at 350mA are listed below

Color	Order Code of ELSH	Minimum Luminous Flux (lm)	CCT (K) Wavelength (nm)	Forward Voltage (V)	CRI (Typical)
Cool White 6500	ELSH-F71C1-0LPES-C6500	70	6500-1~6500-4	2.95~3.85	70
	ELSH-F81C1-0LPES-C6500	80	6500-1~6500-4	2.95~3.85	70
Cool White 5700	ELSH-F71C1-0LPES-C5700	70	5700-1~5700-4	2.95~3.85	70
	ELSH-F81C1-0LPES-C5700	80	5700-1~5700-4	2.95~3.85	70
	ELSH-F71C1-0LPGS-C5700	70	5700-1~5700-4	2.95~3.85	80
	ELSH-F81C1-0LPGS-C5700	80	5700-1~5700-4	2.95~3.85	80
Warm White 3000	ELSH-F51M1-0LPKS-C3000	52	3000-1~3000-4	2.95~3.85	80
	ELSH-F61M1-0LPKS-C3000	60	3000-1~3000-4	2.95~3.85	80
	ELSH-F41M1-0LPGS-C3000	45	3000-1~3000-4	2.95~3.85	90
	ELSH-F51M1-0LPGS-C3000	52	3000-1~3000-4	2.95~3.85	90

PN of the Shuen series: Color LEDs

The below table lists the binning options for the Everlight Shuen series Color LED. Standard Everlight color bins are listed according to wavelength and represent the standard primary colors of the spectrum. Flux bins are listed, with blue highlighted bins as the highest flux bins available. These highlighted bins are not available for selection on their own. The highest flux bins must be purchased with the lower ranked adjacent bin. Consult with your local Everlight sales representative to obtain further information. These clearly listed binning options allow for proper design and implementation into lighting applications.

For Example: If you order product using P/N **ELSH-F41R1-0LPNM-AR5R6**, you will get

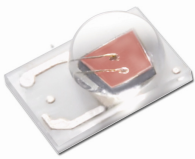

Color Variant	Radiation Pattern	Dominant Wavelength (nm)	Forward Voltage (V)	Minimum Luminous Flux (lm)
Red	Lambertian	620~625(R5) 625~630(R6)	1.75~2.05(U1) 2.05~2.35(U2) 2.35~2.65(U3)	45

Color, Shuen series LEDs at 350mA are listed below.

Color	Order Code of ELSH	Minimum Luminous Flux (lm)	Wavelength (nm)	Forward Voltage(V)
Red	ELSH-F31R1-0LPNM-AR5R6	39	620~630	1.75~2.65
	ELSH-F41R1-0LPNM-AR5R6	45	620~630	1.75~2.65
	ELSH-F51R1-0LPNM-AR5R6	52	620~630	1.75~2.65
Orange	ELSH-F31O1-0LPNM-AR3R4	39	610~620	1.75~2.65
	ELSH-F41O1-0LPNM-AR3R4	45	610~620	1.75~2.65
	ELSH-F51O1-0LPNM-AR3R4	52	610~620	1.75~2.65
Amber	ELSH-F31Y1-0LPNM-AA3A5	39	585~592.5	1.75~2.65
	ELSH-F41Y1-0LPNM-AA3A5	45	585~592.5	1.75~2.65
	ELSH-F51Y1-0LPNM-AA3A5	52	585~592.5	1.75~2.65
	ELSH-F31Y1-0LPNM-AA4A6	39	587.5~595	1.75~2.65
	ELSH-F41Y1-0LPNM-AA4A6	45	587.5~595	1.75~2.65
	ELSH-F51Y1-0LPNM-AA4A6	52	587.5~595	1.75~2.65
Green	ELSH-F71G1-0LPNM-CG1G2	70	520~530	2.95~3.85
	ELSH-F81G1-0LPNM-CG1G2	80	520~530	2.95~3.85
	ELSH-F71G1-0LPNM-CG2G3	70	525~535	2.95~3.85
	ELSH-F81G1-0LPNM-CG2G3	80	525~535	2.95~3.85
Blue	ELSH-E61B1-0LPNM-CB7B8	13	460~470	2.95~3.85
	ELSH-E71B1-0LPNM-CB7B8	17	460~470	2.95~3.85

Average Lumen Maintenance Characteristics

It is well known that the benefits of LED devices are environmental friendliness, energy savings, and long lifetime. In accordance to these advantages, the Shuen series enhances the performance of products that utilize Everlight LED technology. The Shuen series is RoHS compliant and contains no lead. In addition the high efficiency of the Shuen series allows for high energy savings. The life-time of the Shuen series as well as other LEDs is defined as the percentage of initial light output remaining after a specified period of time.

The Shuen series color variations such as cool-white, neutral-white, warm-white, green, cyan, blue, and royal-blue average 65,000 hours for 70% lumen maintenance (B50 L70) under 350mA operating current. This projection is based on constant current operation with junction temperature maintained at or below 135°C

The Shuen series color variations such as red, orange, amber, and royal-red average 65,000 hours for 70% lumen maintenance (B50 L70) under 350mA operating current. This projection is based on constant current operation with junction temperature maintained at or below 110°C

Environmental Compliance

Among the global Solid-State Lighting market, Everlight always does its best to offer the most environmental friendly product to our partners. The Shuen series is available to the European Union directives on the restriction of hazardous substances in electronic equipment, namely the RoHS directive. All materials and processes of the Shuen series are free of form lead, mercury, cadmium, hexavalent, polybrominated biphenyls (PBB) or polybrominated diphenyl ethers (PBDE).

Product Binning

Luminous Flux Bins

Group	Bin	Minimum Photometric Flux (lm)	Maximum Photometric Flux (lm)
E	1	4	5
	2	5	6
	3	6	8
	4	8	10
	5	10	13
	6	13	17
	7	17	20
	8	20	23
	9	23	27
F	1	27	33
	2	33	39
	3	39	45
	4	45	52
	5	52	60
	6	60	70
	7	70	80
	8	80	90
	9	90	100

Group	Bin	Minimum Photometric Flux (lm)	Maximum Photometric Flux (lm)
J	1	100	120
	2	120	140
	3	140	160
	4	160	180
	5	180	200
	6	200	250
	7	250	300
	8	300	350
	9	350	400
K	1	400	450
	2	450	500
	3	500	570
	4	570	640
	5	640	710
	6	710	800
	7	800	900
	8	900	1000
	9	1000	1200
N	1	1200	1400
	2	1400	1600
	3	1600	1800

Radiometric Power Bins

Group	Bin	Minimum Radiometric Power(mW)	Maximum Radiometric Power(mW)
Q	1	0	25
	2	25	50
	3	50	75
	4	75	100
	5	100	125
	6	125	175
	7	175	225
	8	225	275
	9	275	350

Group	Bin	Minimum Radiometric Power(mW)	Maximum Radiometric Power(mW)
R	1	350	425
	2	425	500
	3	500	600
	4	600	700
	5	700	800
	6	800	900
	7	900	1000
	8	1000	1300
	9	1300	1600

White Bin Structure

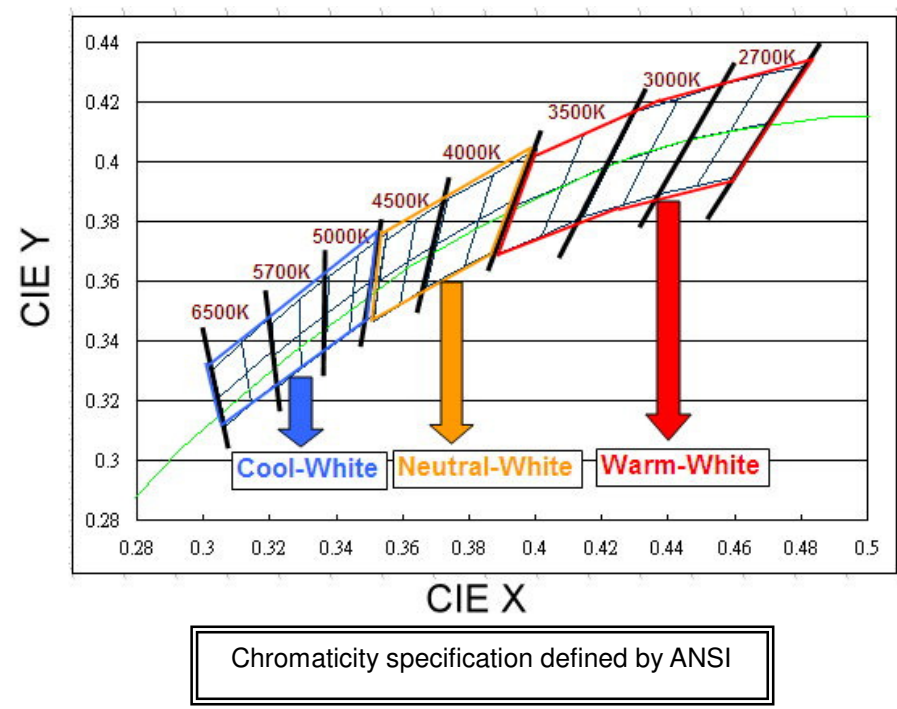

Notes:

1. The CCT range of Cool-White varies from 4745K to 7050K.
2. The CCT range of Neutral-White varies from 3710K to 4745K.
3. The CCT range of Warm-White varies from 2580K to 3710K
4. Color coordinates measurement allowance : ± 0.01
5. Color bins are defined at $I_f=350\text{mA}$ operation.

Cool-White Bin Structure

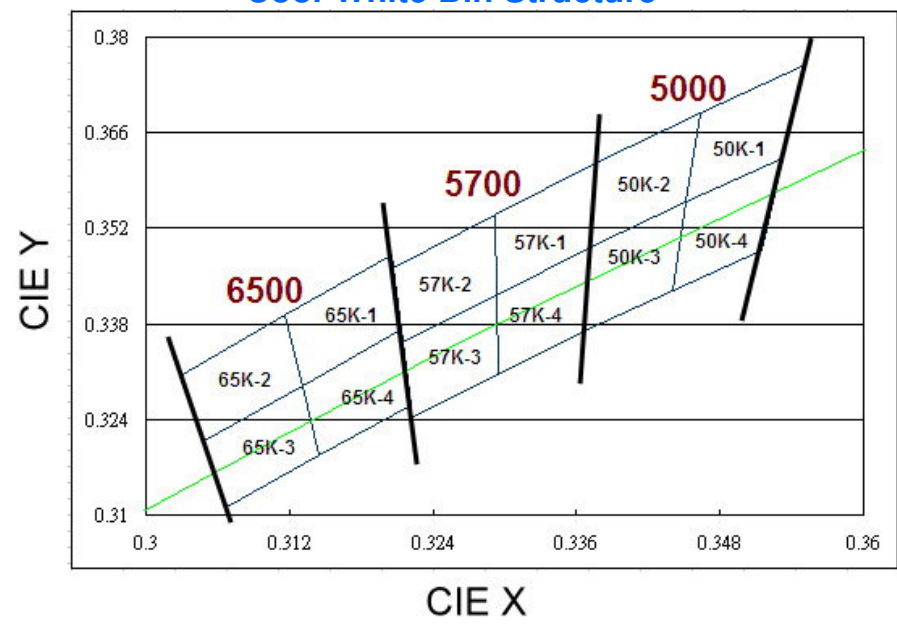

Cool-White Bin Coordinates

5000K

Bin	CIE X	CIE Y
50K-1	0.346	0.369
	0.345	0.356
	0.353	0.362
	0.355	0.376
Reference Range: 4745~5000K		

Bin	CIE X	CIE Y
50K-2	0.338	0.362
	0.337	0.349
	0.345	0.356
	0.346	0.369
Reference Range: 5000~5310K		

Bin	CIE X	CIE Y
50K-4	0.345	0.356
	0.344	0.343
	0.352	0.349
	0.353	0.362
Reference Range: 4745~5000K		

Bin	CIE X	CIE Y
50K-3	0.337	0.349
	0.337	0.337
	0.344	0.343
	0.345	0.356
Reference Range: 5000~5310K		

5700K

Bin	CIE X	CIE Y
57K-1	0.329	0.354
	0.329	0.342
	0.337	0.349
	0.338	0.362
Reference Range: 5310~5700K		

Bin	CIE X	CIE Y
57K-2	0.321	0.346
	0.321	0.335
	0.329	0.342
	0.329	0.354
Reference Range: 5700~6020K		

Bin	CIE X	CIE Y
57K-4	0.329	0.342
	0.329	0.331
	0.337	0.337
	0.337	0.349
Reference Range: 5310~5700K		

Bin	CIE X	CIE Y
57K-3	0.321	0.335
	0.322	0.324
	0.329	0.331
	0.329	0.342
Reference Range: 5700~6020K		

6500K

Bin	CIE X	CIE Y
65K-1	0.312	0.339
	0.313	0.329
	0.321	0.337
	0.321	0.348
Reference Range: 6020~6500K		

Bin	CIE X	CIE Y
65K-2	0.303	0.330
	0.305	0.321
	0.313	0.329
	0.312	0.339
Reference Range: 6500~7050K		

Bin	CIE X	CIE Y
65K-4	0.313	0.329
	0.314	0.319
	0.322	0.326
	0.321	0.337
Reference Range: 6020~6500K		

Bin	CIE X	CIE Y
65K-3	0.305	0.321
	0.307	0.311
	0.314	0.319
	0.313	0.329
Reference Range: 6500~7050K		

Neutral-White Bin Structure

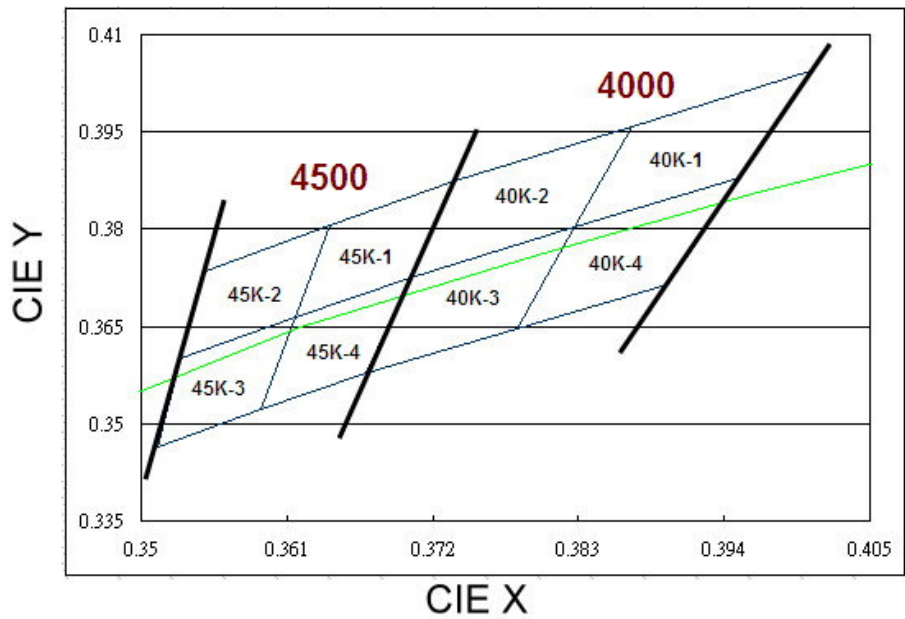

Neutral-White Bin Coordinates

4000K

Bin	CIE X	CIE Y
40K-1	0.387	0.396
	0.383	0.380
	0.395	0.388
	0.401	0.404
Reference Range: 3710~4000K		

Bin	CIE X	CIE Y
40K-2	0.374	0.387
	0.370	0.373
	0.383	0.380
	0.387	0.396
Reference Range: 4000~4260K		

Bin	CIE X	CIE Y
40K-4	0.383	0.380
	0.378	0.365
	0.390	0.372
	0.395	0.388
Reference Range: 3710~4000K		

Bin	CIE X	CIE Y
40K-3	0.370	0.373
	0.367	0.358
	0.378	0.365
	0.383	0.380
Reference Range: 4000~4260K		

4500K

Bin	CIE X	CIE Y
45K-1	0.364	0.381
	0.362	0.366
	0.370	0.373
	0.374	0.387
Reference Range: 4260~4500K		

Bin	CIE X	CIE Y
45K-2	0.355	0.374
	0.353	0.360
	0.362	0.366
	0.364	0.381
Reference Range: 4500~4745K		

Bin	CIE X	CIE Y
45K-4	0.362	0.366
	0.359	0.352
	0.367	0.358
	0.370	0.373
Reference Range: 4260~4500K		

Bin	CIE X	CIE Y
45K-3	0.353	0.360
	0.351	0.347
	0.359	0.352
	0.362	0.366
Reference Range: 4500~4745K		

Warm-White Bin Structure

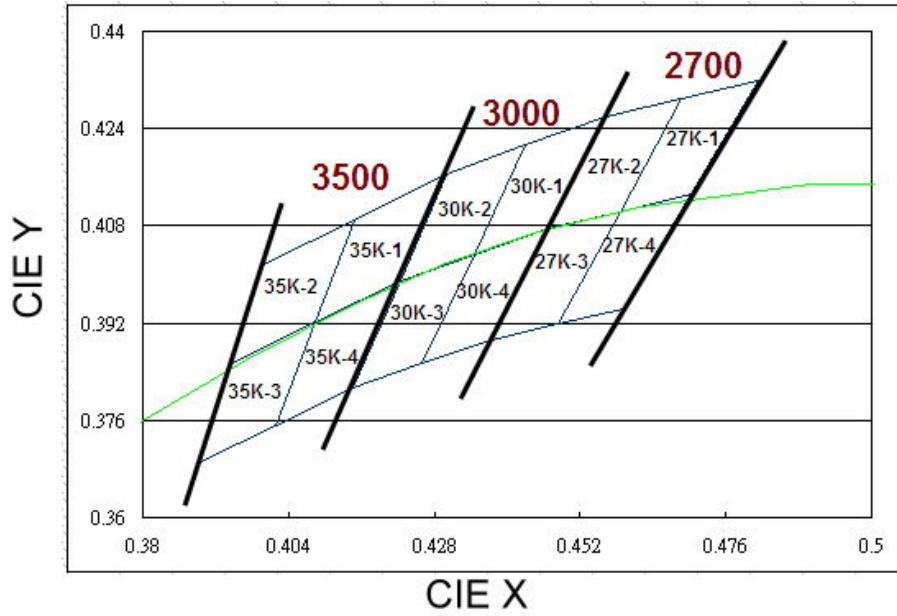

Warm-White Bin Coordinates

2700K

Bin	CIE X	CIE Y
27K-1	0.469	0.429
	0.459	0.410
	0.470	0.413
	0.481	0.432
Reference Range: 2580~2700K		

Bin	CIE X	CIE Y
27K-2	0.456	0.426
	0.447	0.408
	0.459	0.410
	0.469	0.429
Reference Range: 2700~2870K		

Bin	CIE X	CIE Y
27K-4	0.459	0.410
	0.448	0.392
	0.459	0.394
	0.470	0.413
Reference Range: 2580~2700K		

Bin	CIE X	CIE Y
27K-3	0.447	0.408
	0.437	0.389
	0.448	0.392
	0.459	0.410
Reference Range: 2700~2870K		

3000K

Bin	CIE X	CIE Y
30K-1	0.443	0.421
	0.435	0.403
	0.447	0.408
	0.456	0.426
Reference Range: 2870~3000K		

Bin	CIE X	CIE Y
30K-2	0.430	0.417
	0.422	0.399
	0.435	0.403
	0.443	0.421
Reference Range: 3000~3220K		

Bin	CIE X	CIE Y
30K-4	0.435	0.403
	0.426	0.385
	0.437	0.389
	0.447	0.408
Reference Range: 2870~3000K		

Bin	CIE X	CIE Y
30K-3	0.422	0.399
	0.415	0.381
	0.426	0.385
	0.435	0.403
Reference Range: 3000~3220K		

3500K

Bin	CIE X	CIE Y
35K-1	0.415	0.409
	0.408	0.392
	0.422	0.399
	0.430	0.417
Reference Range: 3220~3500K		

Bin	CIE X	CIE Y
35K-2	0.400	0.402
	0.394	0.385
	0.408	0.392
	0.415	0.409
Reference Range: 3500~3710K		

Bin	CIE X	CIE Y
35K-4	0.408	0.392
	0.402	0.375
	0.415	0.381
	0.422	0.399
Reference Range: 3220~3500K		

Bin	CIE X	CIE Y
35K-3	0.394	0.385
	0.389	0.369
	0.402	0.375
	0.408	0.392
Reference Range: 3500~3710K		

Forward Voltage Bins

Group Name	Bins
A	U1+U2+U3
B	U2+U3+U4
C	V1+V2+V3
D	V2+V3+V4
E	V3+V4+V5
F	V1+V2
G	V1

Bin	Minimum Forward Voltage (V)	Maximum Forward Voltage (V)
U1	1.75	2.05
U2	2.05	2.35
U3	2.35	2.65
U4	2.65	2.95
V1	2.95	3.25
V2	3.25	3.55
V3	3.55	3.85
V4	3.85	4.15
V5	4.15	4.45

Notes:

1. Forward voltage measurement tolerance: $\pm 0.1V$.
2. Forward voltage bins are defined at $I_f=350$ mA operation.

Color Bins

Group	Bin	Minimum Dominant Wavelength (nm)	Maximum Dominant Wavelength (nm)
B (Blue)	1	430	435
	2	435	440
	3	440	445
	4	445	450
	5	450	455
	6	455	460
	7	460	465
	8	465	470
C (Cyan)	1	490	495
	2	495	500
	3	500	505
	4	505	510
	5	510	515
	6	515	520
G (Green)	1	520	525
	2	525	530
	3	530	535
	4	535	540
	5	540	545
	6	545	550
A (Amber)	1	580	582.5
	2	582.5	585
	3	585	587.5
	4	587.5	590
	5	590	592.5
	6	592.5	595
R (Red)	3	610	615
	4	615	620
	5	620	625
	6	625	630
	7	630	635
D (Deep-Red)	1	635	640
	2	640	645
	3	645	650
	4	650	655
	5	655	660
	6	660	665

Notes.

1. Dominant wavelength measurement tolerance: $\pm 0.5\text{nm}$.
2. Dominant wavelength bins are defined at $I_f=350\text{ mA}$ operation.

Optical Characteristics

Color	Part Number	Part Number Dominant Wavelength λ_D Peak Wavelength λ_P Color Temperature CCT			Typical Temperature Coefficient of Dominant Wavelength (nm/°C) - ($\Delta\lambda_D/\Delta T_J$)	Thermal Resistance (°C/W)	Typical Viewing Angle (degrees) $2\theta_{1/2}$
		Min.	Typ.	Max.			
Cool-White	ELSH – XX1CX	4745K	5700K	7050K	---	10	120
Neutral-White	ELSH – XX1NX	3710K	4260K	4745K	---	10	120
Warm-White	ELSH – XX1MX	2580K	3000K	3710K	---	10	120
Red	ELSH – XX1RX	620nm	---	630nm	0.05	12	120
Orange	ELSH – XX1OX	610nm	---	620nm	0.08	12	120
Amber	ELSH – XX1YX	585nm	---	595nm	0.1	12	120
Green	ELSH – XX1GX	520nm	---	535nm	0.05	10	120
Blue	ELSH – XX1BX	460nm	---	470nm	0.05	10	120
Deep-Red	ELSH – XX1EX	640nm	---	---	0.08	12	120
Royal-Blue	ELSH – XX1LX	430nm	---	460nm	0.04	10	120
Cyan	ELSH – XX1AX	500nm	---	510nm	0.04	10	120

Notes:

1. The test tolerance of Everlight is $\pm 0.5\text{nm}$ for dominant wavelength, $\pm 5\%$ for CCT.
2. Viewing angle is the width of half the light output intensity in all directions of 180° .
3. All Cool-White, Neutral-White, Warm-White, and dominant wavelength below 550nm LEDs are made with Indium Gallium Nitride (InGaN).
4. All LEDs with dominant wavelength exceeding 550nm are made with Aluminum Indium Gallium Phosphide (AlInGaP).
5. The range of wavelength in Deep-Red and Royal-Blue is described as peak-wavelength.

Absolute Maximum Ratings

Parameter	Symbol	Ratings	Unit
DC Forward Current (mA)	I_F	400	mA
Peak Pulse Current (mA)	I_{Pulse}	1000	mA
ESD Resistance	V_B	8000	V
Reverse Voltage	V_R	Note 2	V
Junction Temperature	T_J	150/135 _[3]	°C
Operating Temperature	T_{Opr}	-40 ~ +135/120 _[4]	°C
Storage Temperature	T_{Stg}	-40 ~ +100	°C
Soldering Temperature	T_{Sol}	260	°C
Allowable Reflow Cycles	n/a	3	cycles

Notes:

- Maximum forward current for 1W is 400mA ($T_{Thermal Pad}=25^{\circ}C$).
- The Shuen series LEDs are not designed for reverse bias used.
- Maximum junction temperature of Cool-White, Neutral-White, Warm-White, Blue, Cyan, Green LEDs are 150°C and 135°C for Deep-Red, Red, Amber, Yellow LEDs.
- Maximum Operating Temperature (Thermal Pad) of Cool-White, Neutral-White, Warm-White, Blue, Cyan, Green LEDs are 135°C and 120°C for Deep-Red, Red, Amber, Yellow LEDs.
- Avoid operating Shuen LEDs at maximum operating temperature exceed 1 hour.

JEDEC Moisture Sensitivity

Level	Floor Life		Soak Requirements Standard	
	Time (hours)	Conditions	Time (hours)	Conditions
1	unlimited	$\leq 30^{\circ}C / 85\% RH$	169 (+5/-0)	85°C / 85 RH

Mechanical Dimension

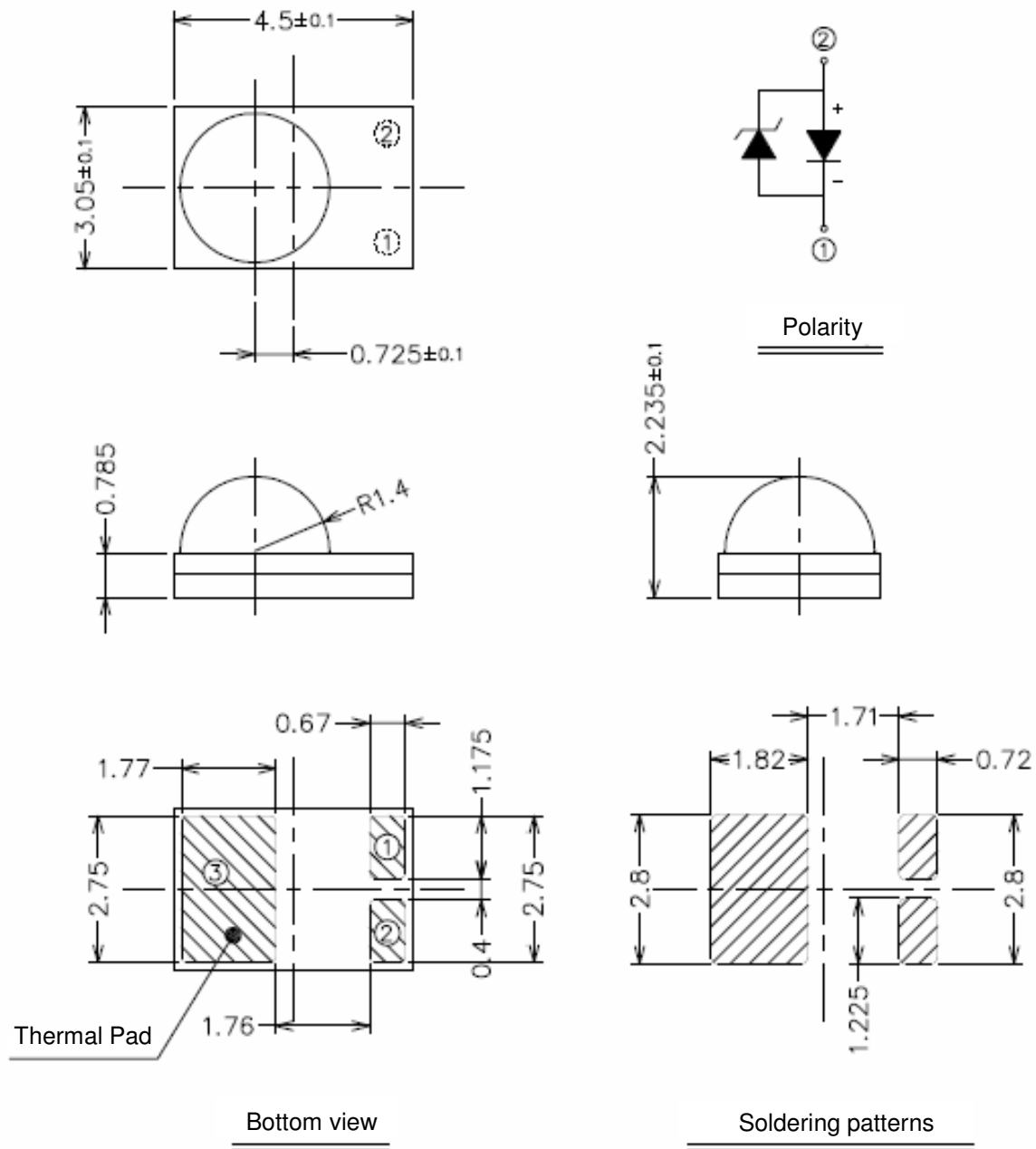

Notes.

1. Dimensions are in millimeters.
2. Tolerances unless mentioned are ± 0.1 mm.
3. Do not handle the device by the lens. Incorrect force applied to the lens may lead to the failure of devices.
4. The thermal pad is electrically isolated from the Anode and Cathode contact pads.

Pad Configuration

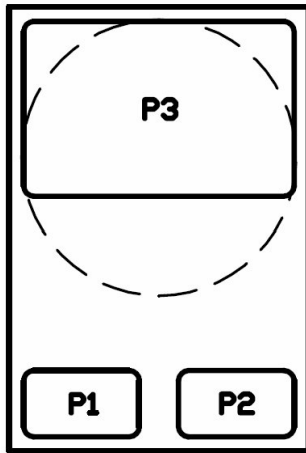

BOTTOM VIEW

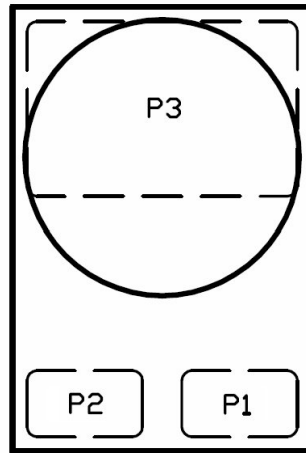

TOP VIEW

PAD	FUNCTION
P1	ANODE
P2	CATHODE
P3	THERMAL PAD

Reflow Soldering Characteristics

For Reflow Process

- a. ELSH series are suitable for SMT processes.
- b. Curing of glue in oven must be according to standard operation flow processes.

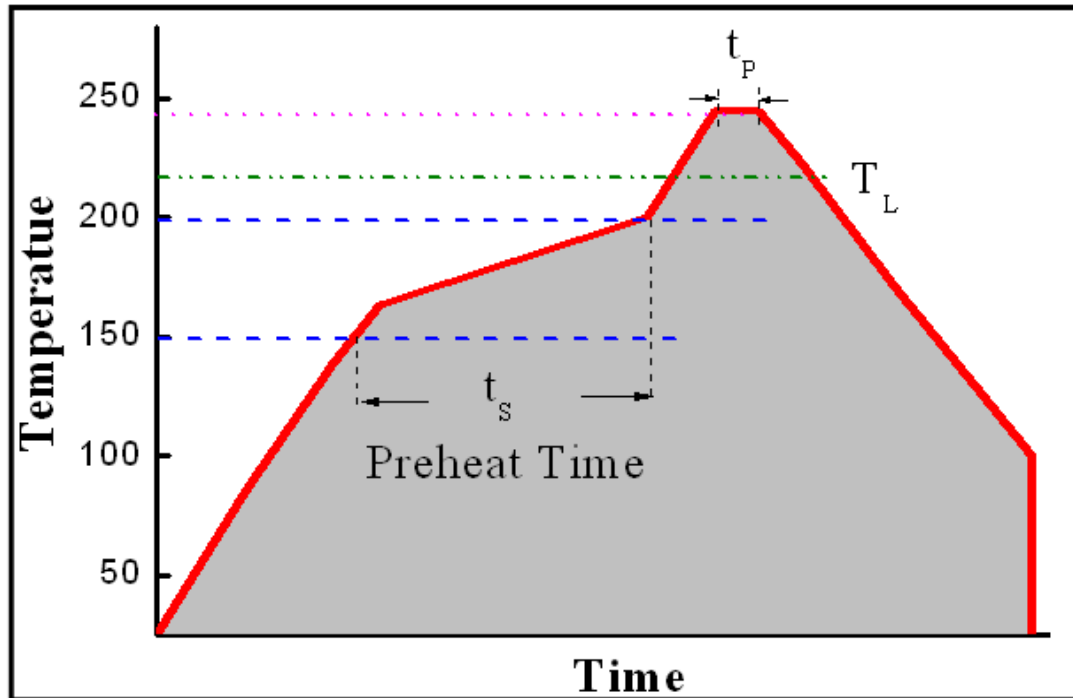

Profile Feature	Lead Free Assembly
Ramp-Up Rate	2-3 °C/S
Preheat Temperature	150-200 °C
Preheat Time (t_s)	60-120 S
Liquid Temperature (T_L)	217 °C
Time maintained above T_L	60-90 S
Peak Temperature (T_P)	240±5 °C
Peak Time (t_p)	Max 20 S
Ramp-Down Rate	3-5 °C/S

- c. Reflow soldering should not be done more than twice.
- d. In soldering process, stress on the LEDs during heating should be avoided.
- e. After soldering, do not bend the circuit board.

Wavelength Characteristics

For Deep-Red, Red, Amber, Yellow, Green, Cyan, Blue, Royal-Blue
@ Thermal Pad Temperature = 25°C

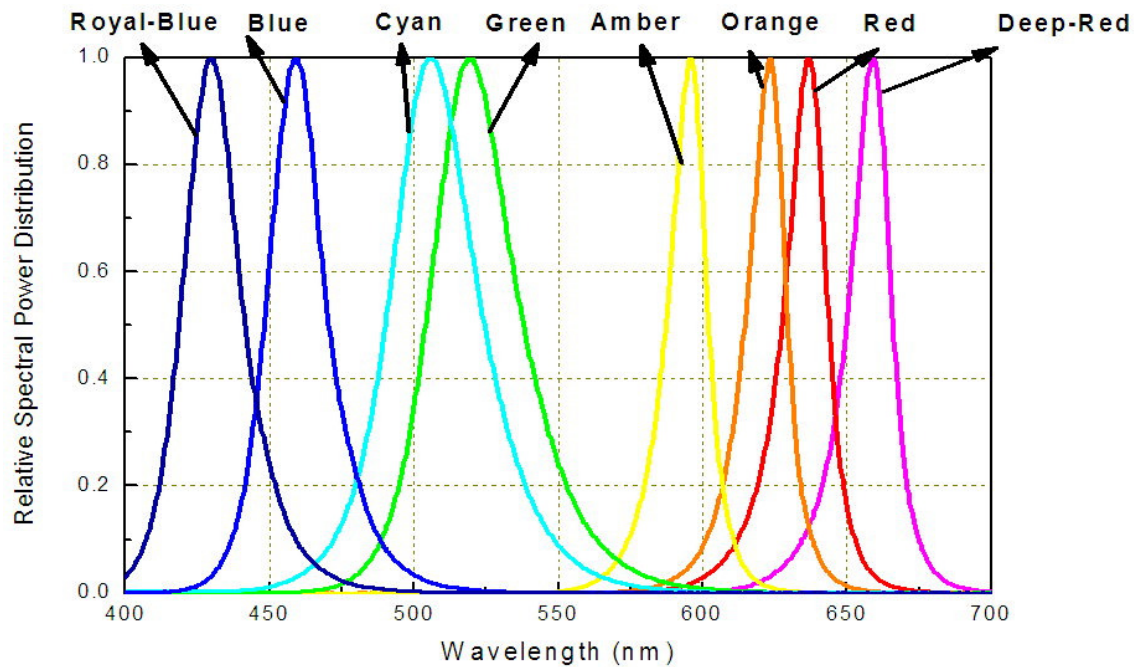

For Cool-White, @ Thermal Pad Temperature = 25°C

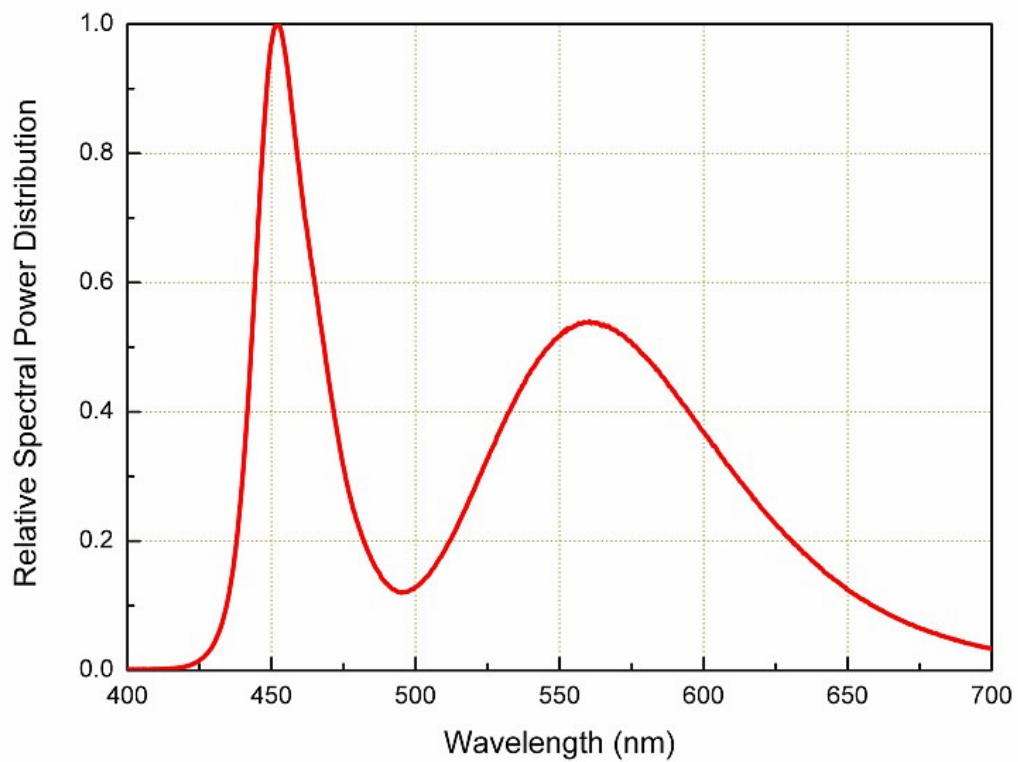

For Neutral-White, @ Thermal Pad Temperature = 25°C

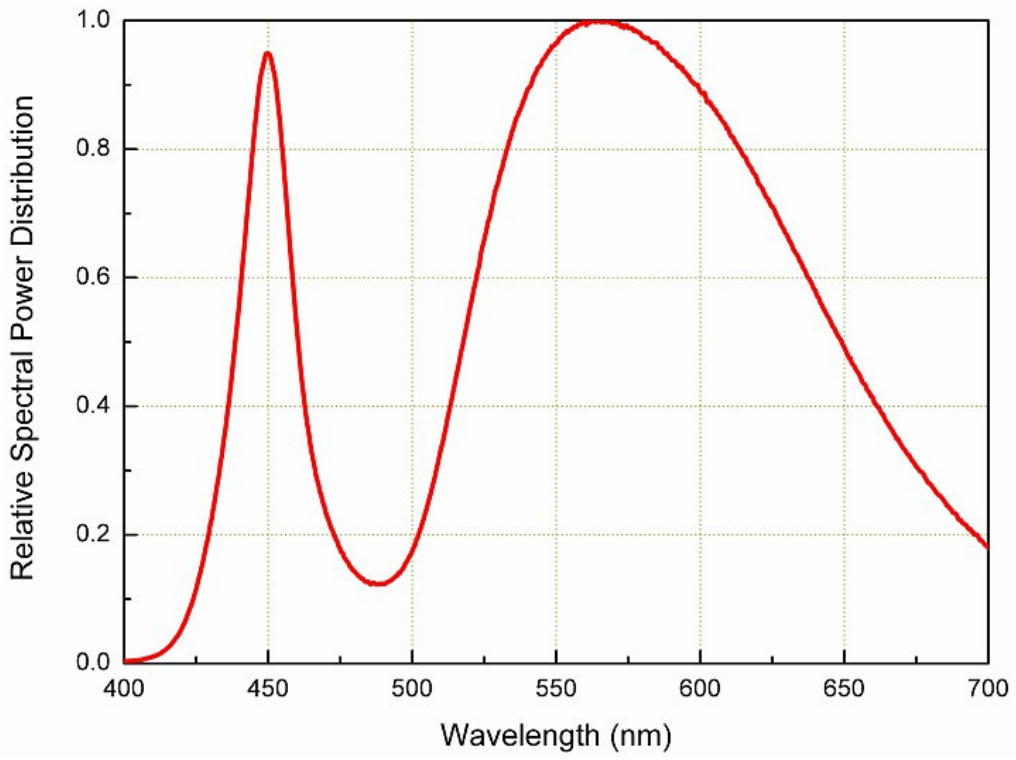

For Warm-White, @ Thermal Pad Temperature = 25°C

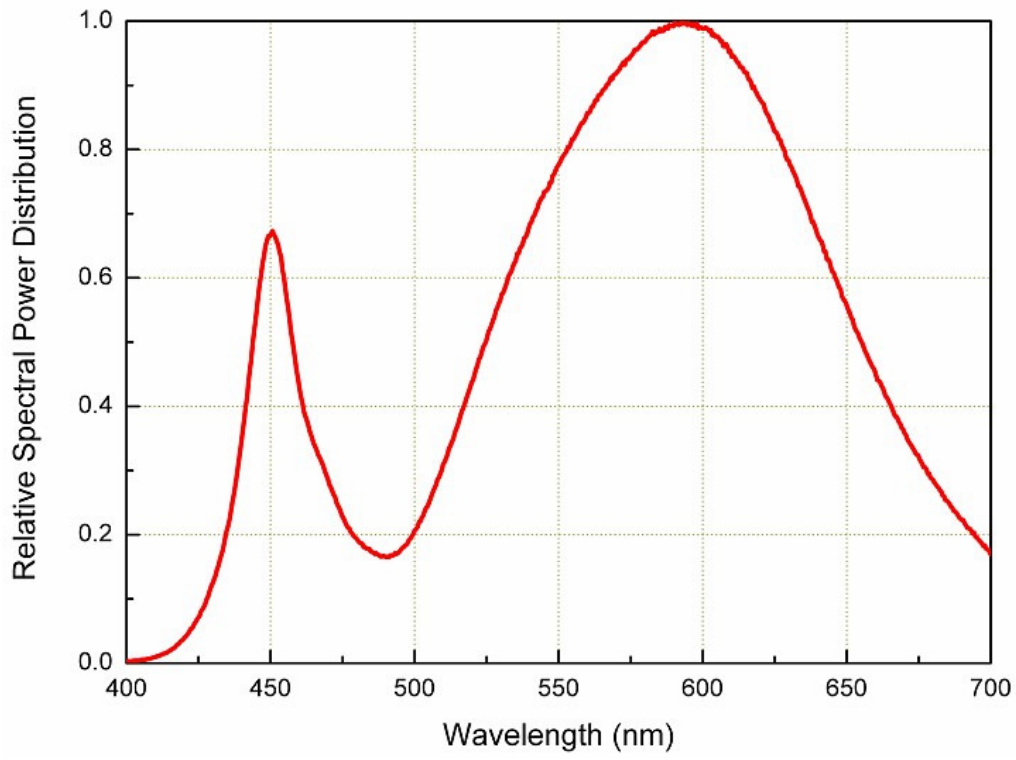

Typical Light Output Characteristic vs. Thermal Pad Temperature

Cool-White, Neutral-White, Warm-White, Green, Cyan, Blue, Royal-Blue for 350mA Drive Current

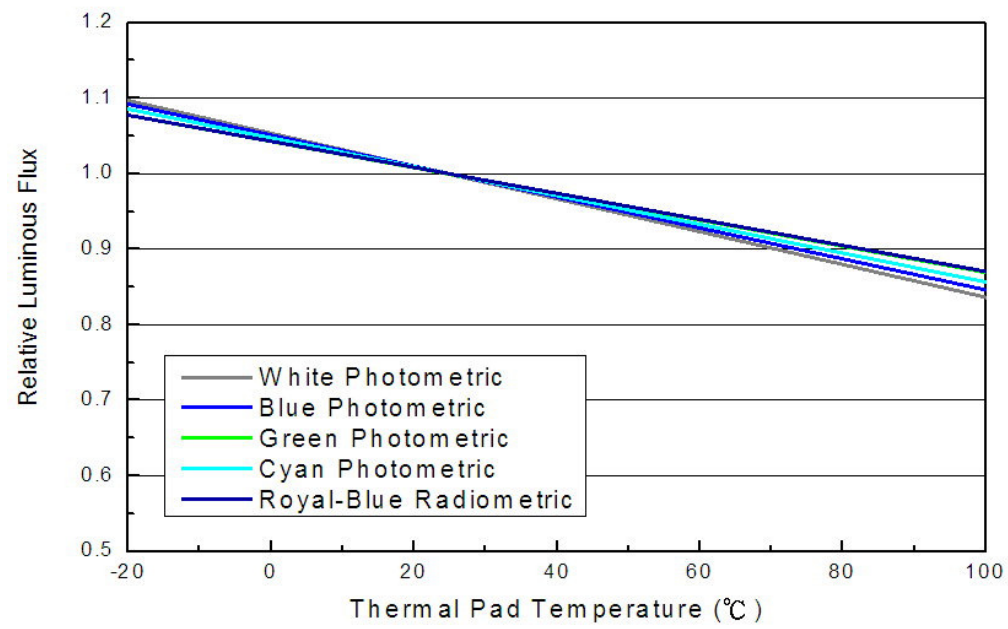

Deep-Red, Red, Orange, Amber for 350mA Drive Current

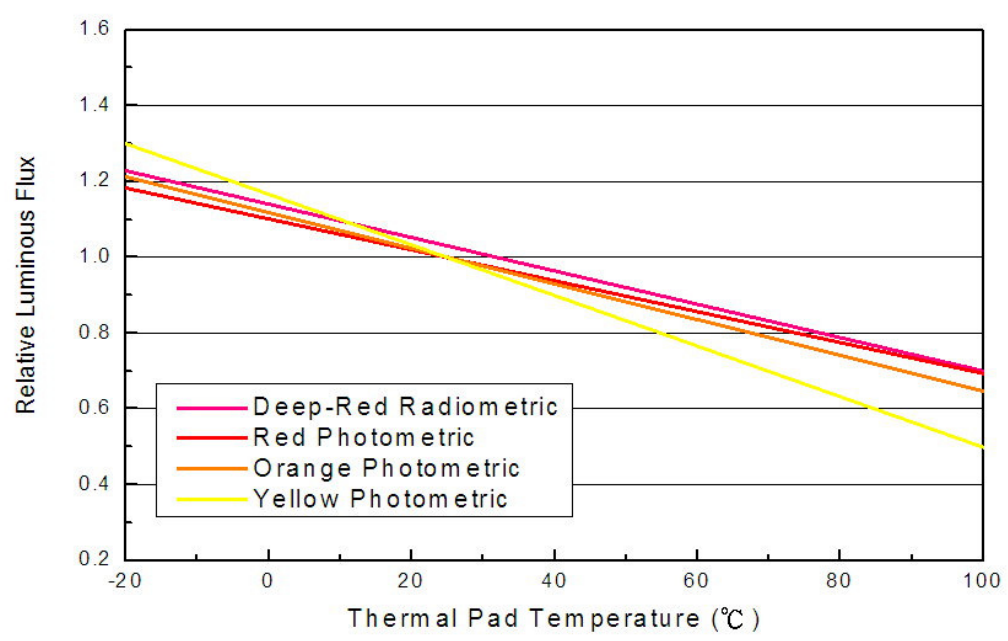

Typical Electrical Characteristics

For Cool-White, Neutral-White, Warm-White, Green, Cyan, Blue, Royal-Blue
@ Thermal Pad Temperature = 25°C

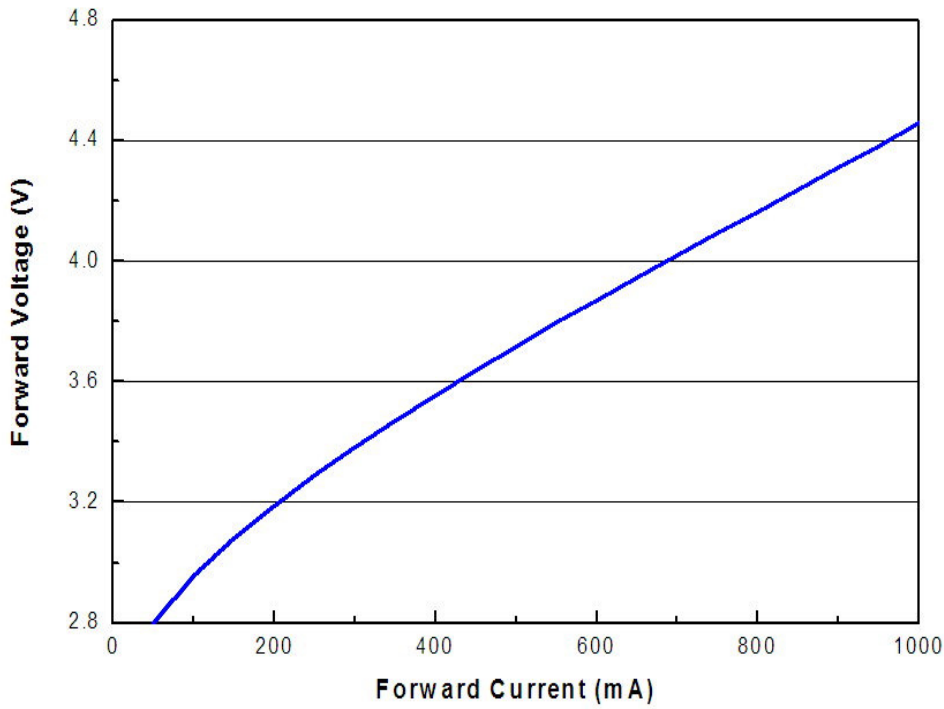

For Deep-Red, Red, Orange, Amber,
@ Thermal Pad Temperature = 25°C

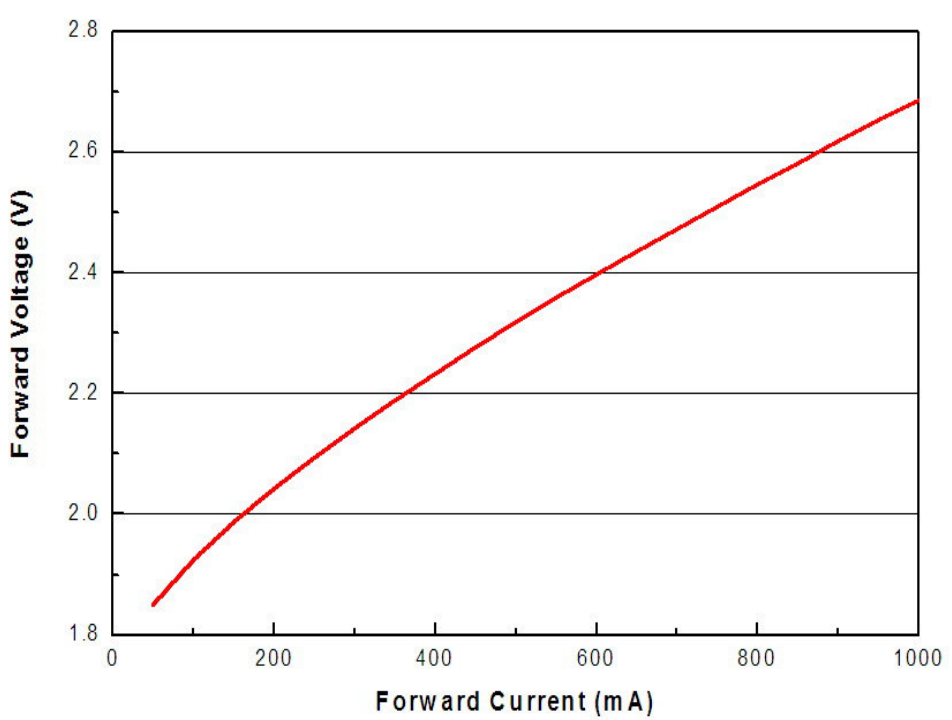

Typical Relative Luminous Flux vs. Forward Current

For Cool-White, Neutral-White, Warm-White
@ Thermal Pad Temperature = 25°C

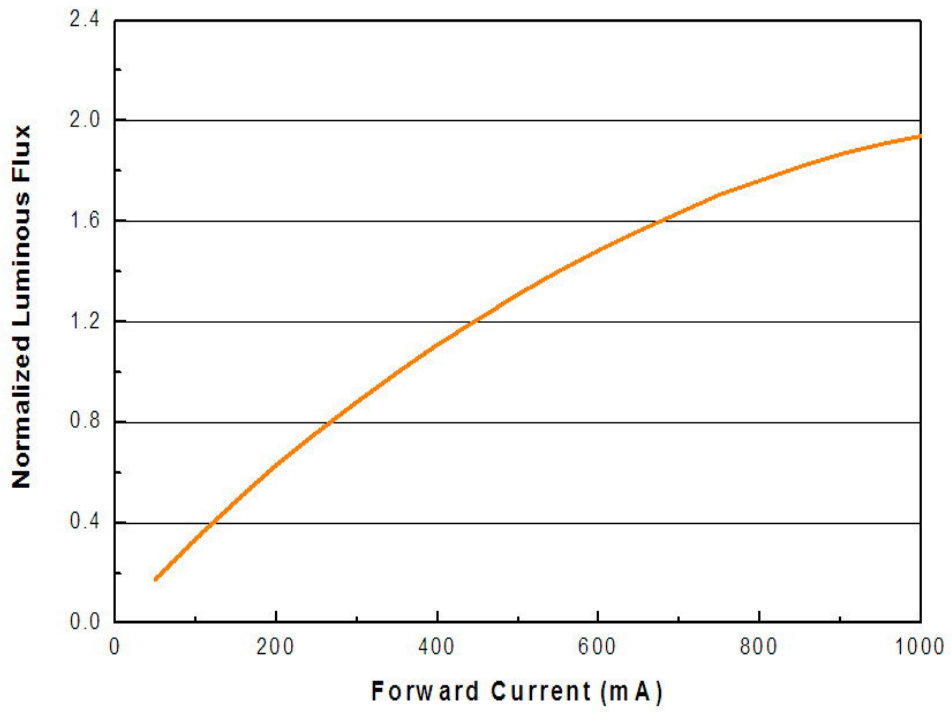

For Green, Cyan, Blue, Royal-Blue @ Thermal Pad Temperature = 25°C

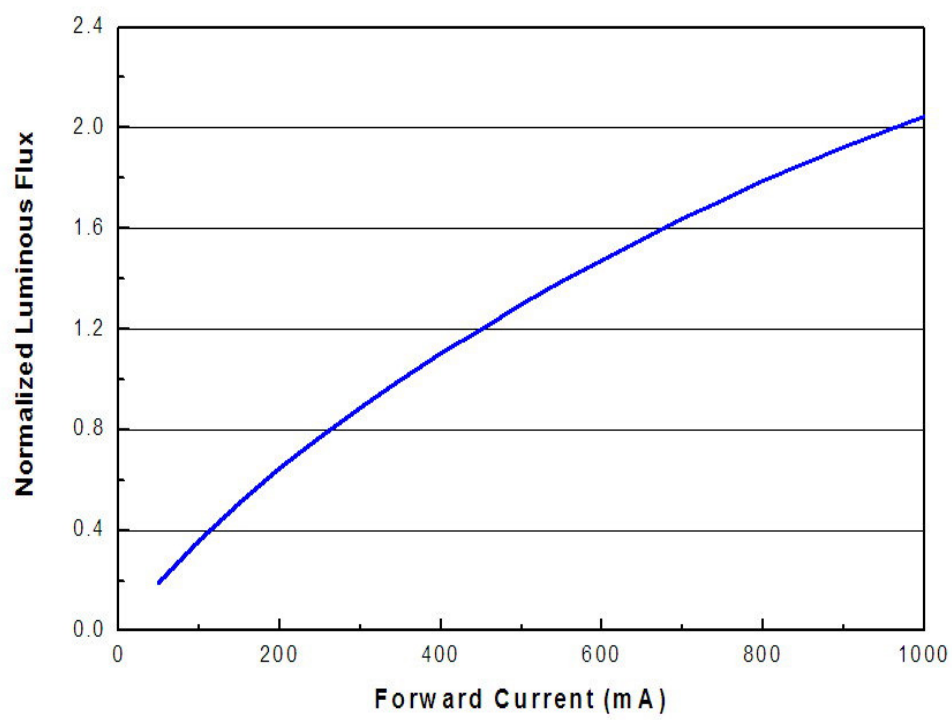

For Deep-Red, Red, Orange, Amber, @ Thermal Pad Temperature = 25°C

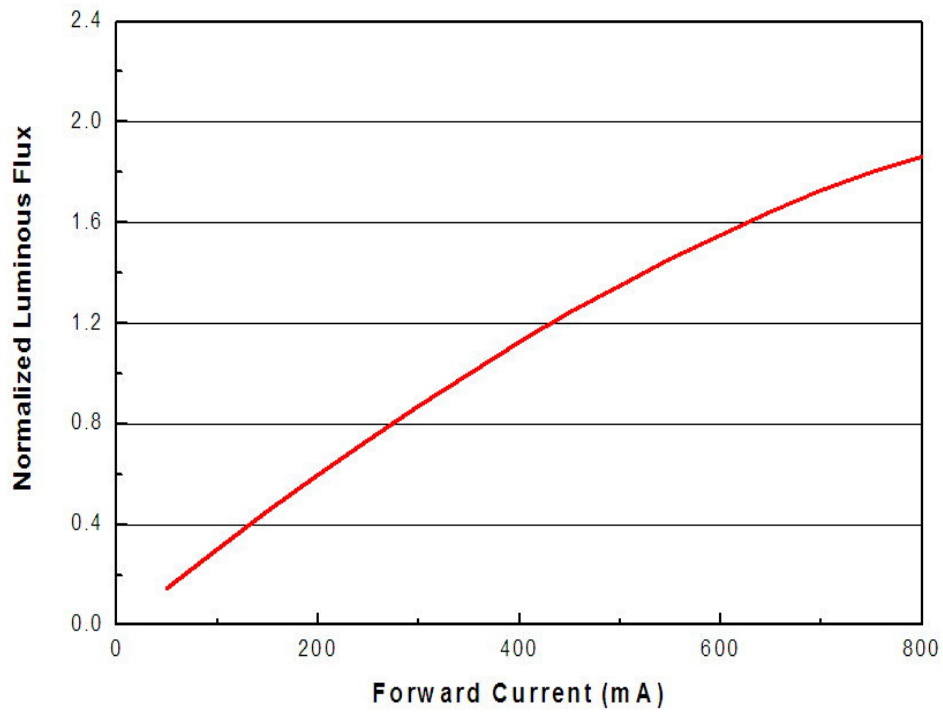

Typical Wavelength & CCT Shift Characteristics vs. Forward Current

For Cool-White @ Thermal Pad Temperature = 25°C

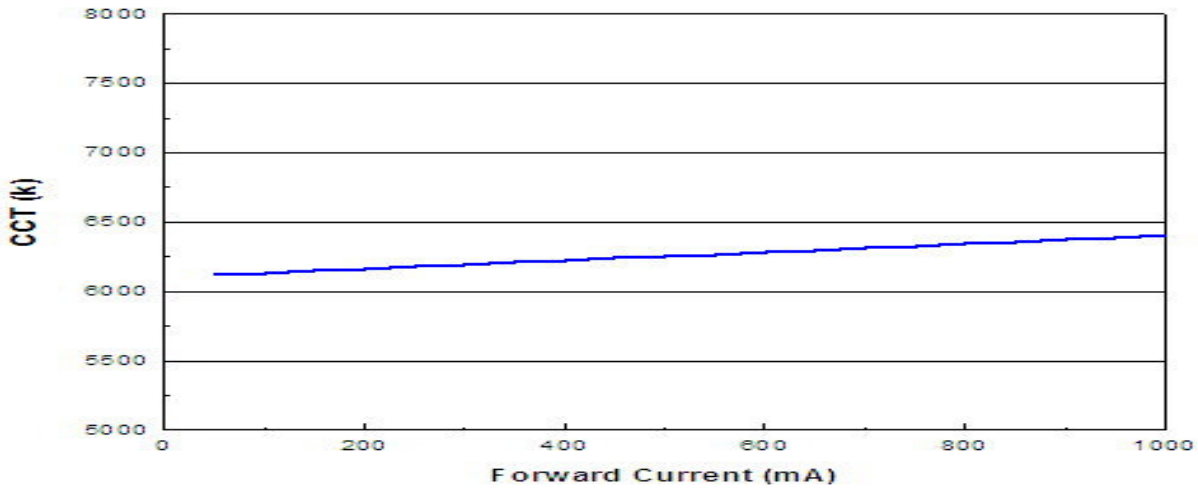

For Neutral-White @ Thermal Pad Temperature = 25°C

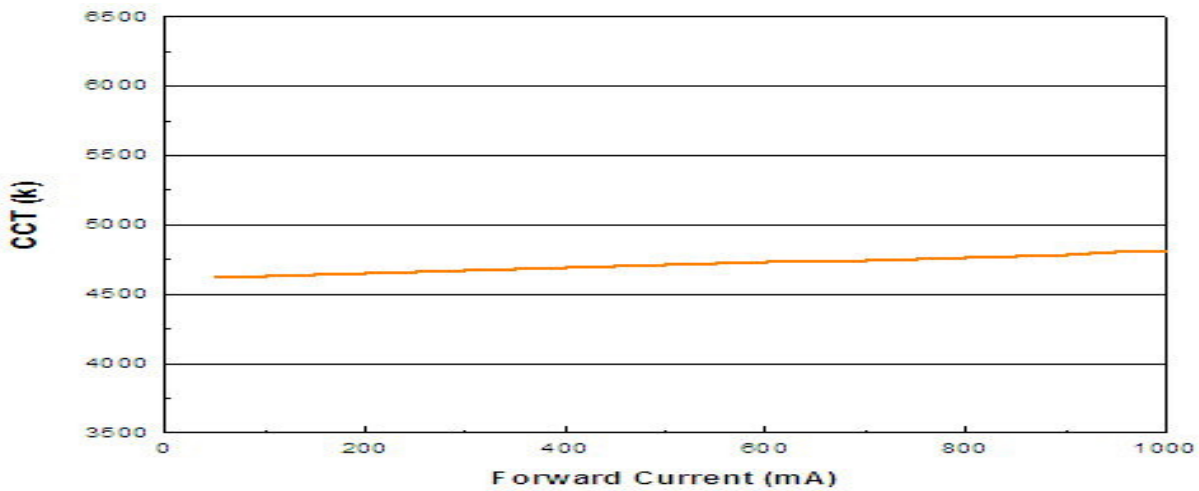

For Warm-White @ Thermal Pad Temperature = 25°C

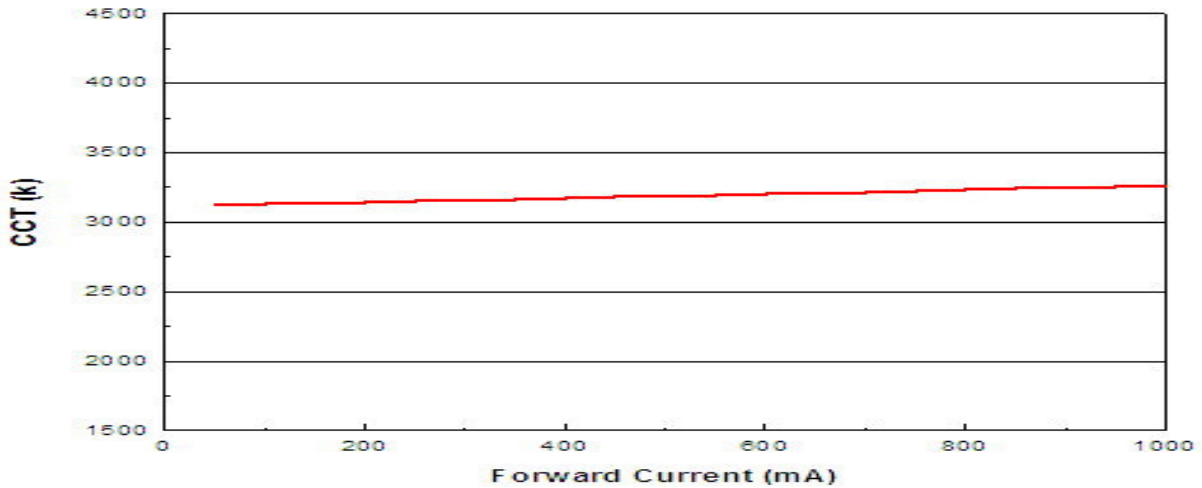

For Blue @ Thermal Pad Temperature = 25°C

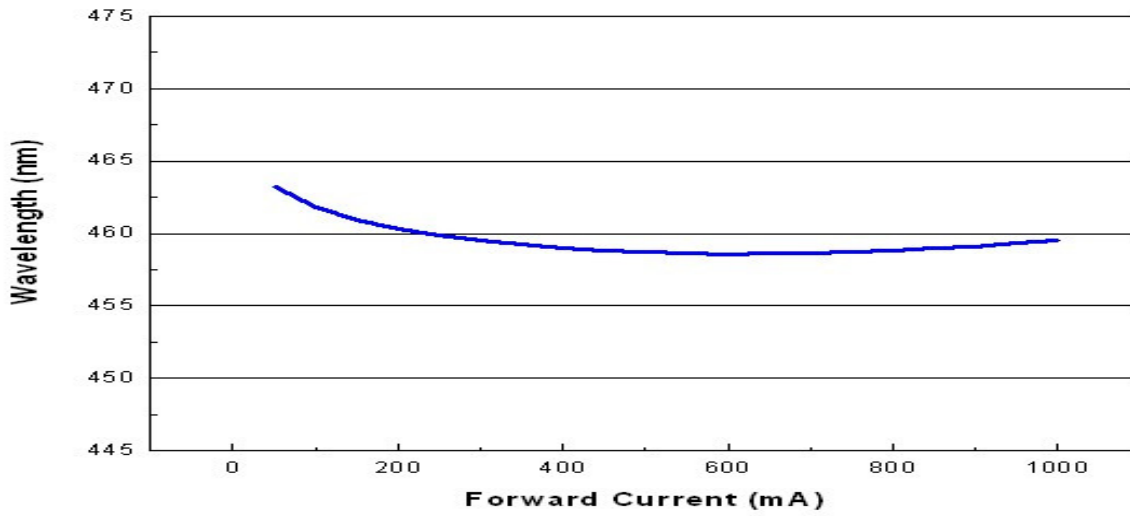

For Green @ Thermal Pad Temperature = 25°C

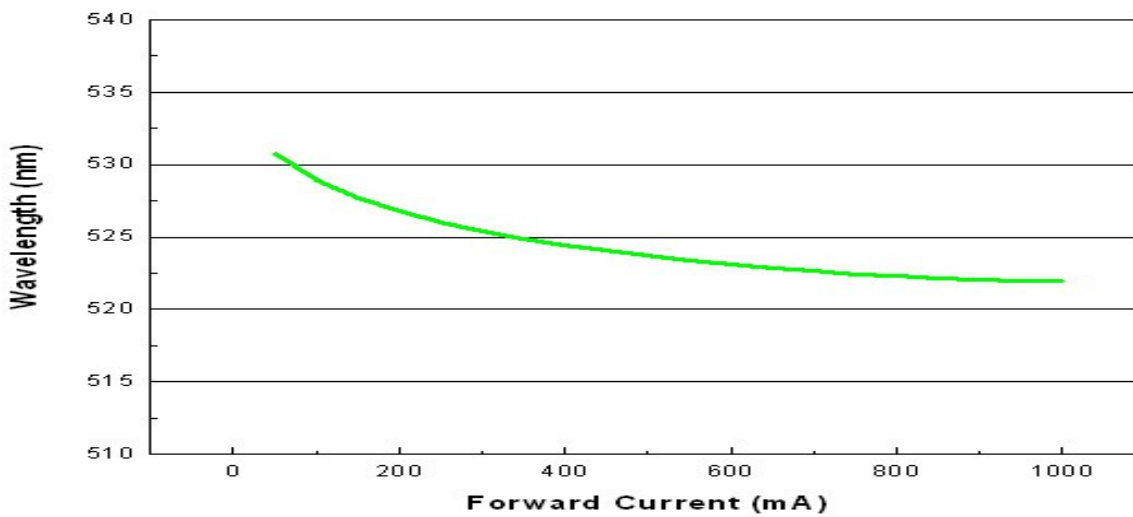

For Red @ Thermal Pad Temperature = 25°C

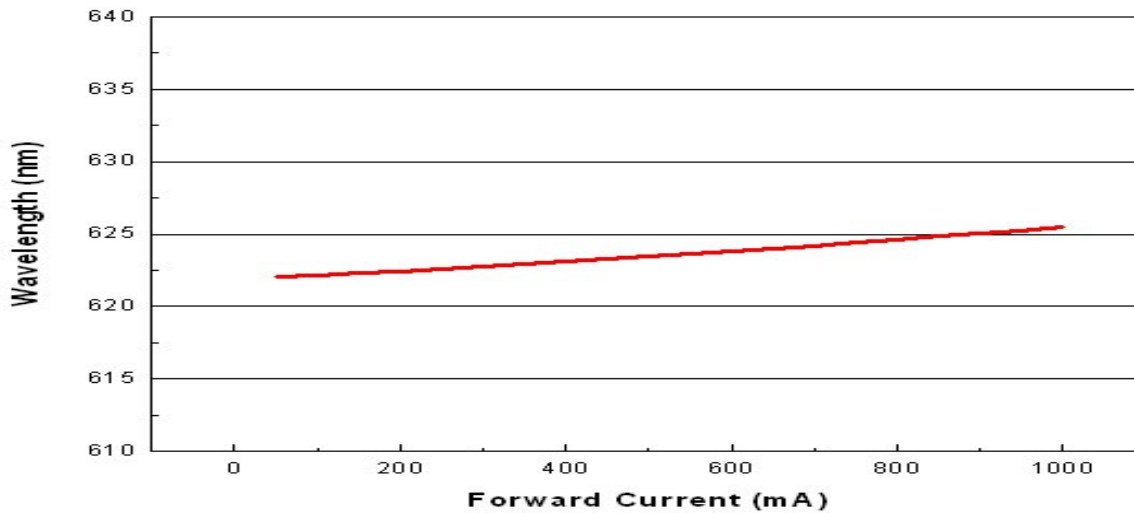

Current Derating Curves

Current Derating Curve for 350mA Drive Current Cool-White, Neutral-White, Warm-White, Green, Cyan, Blue, Royal-Blue

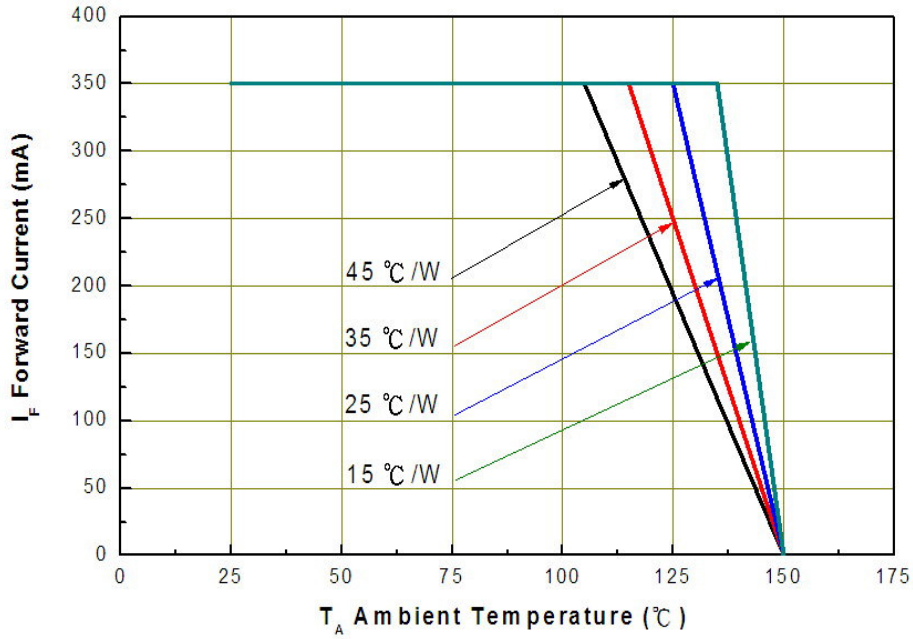

Current Derating Curve for 350mA Drive Current Deep-Red, Red, Amber, Yellow

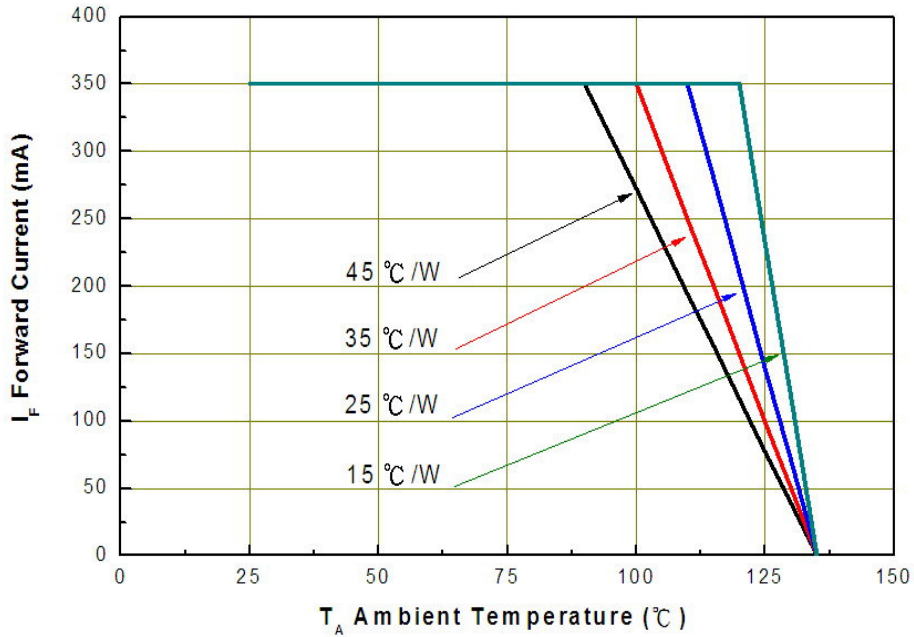

Typical Radiation Patterns

Typical Spatial Radiation Pattern for Cool-White, Neutral-White, Warm-White Lambertian

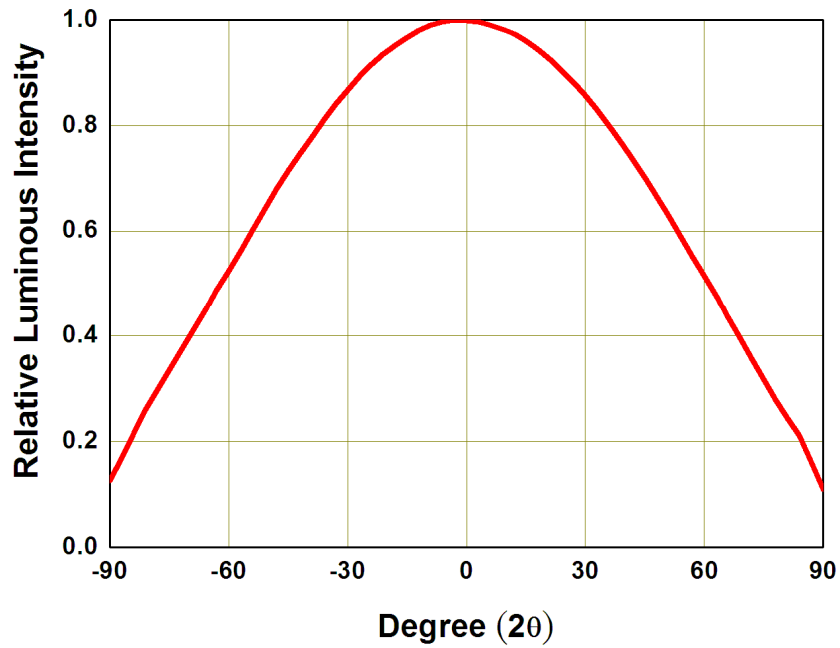

Notes.

1. $2\theta_{1/2}$ is the off axis angle from lamp centerline where the luminous intensity is 1/2 of the peak value.
2. View angle tolerance is $\pm 5^\circ$.

Typical Polar Radiation Pattern for Cool-White, Neutral-White, Warm-White Lambertian

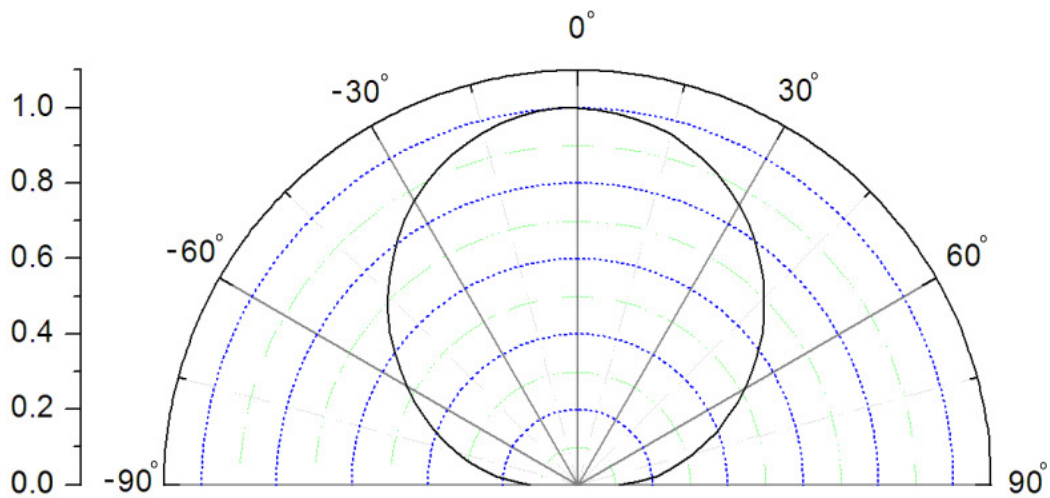

Typical Difference of CIE X of Cool-White Versus Angle

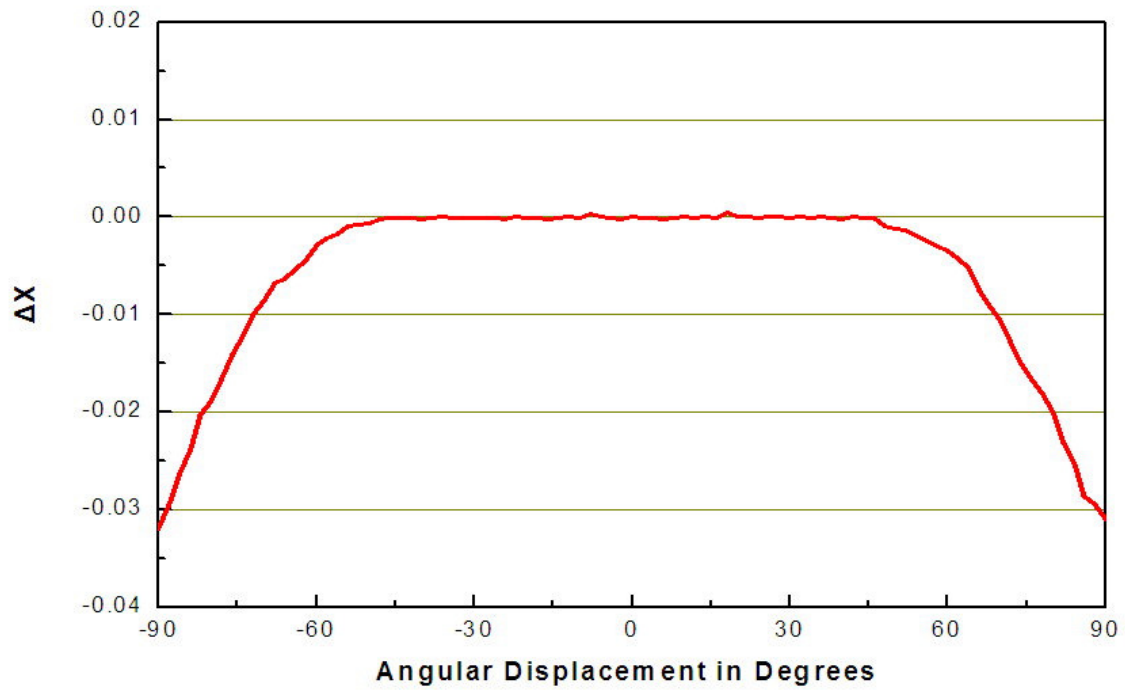

Typical Difference of CIE Y of Cool-White Versus Angle

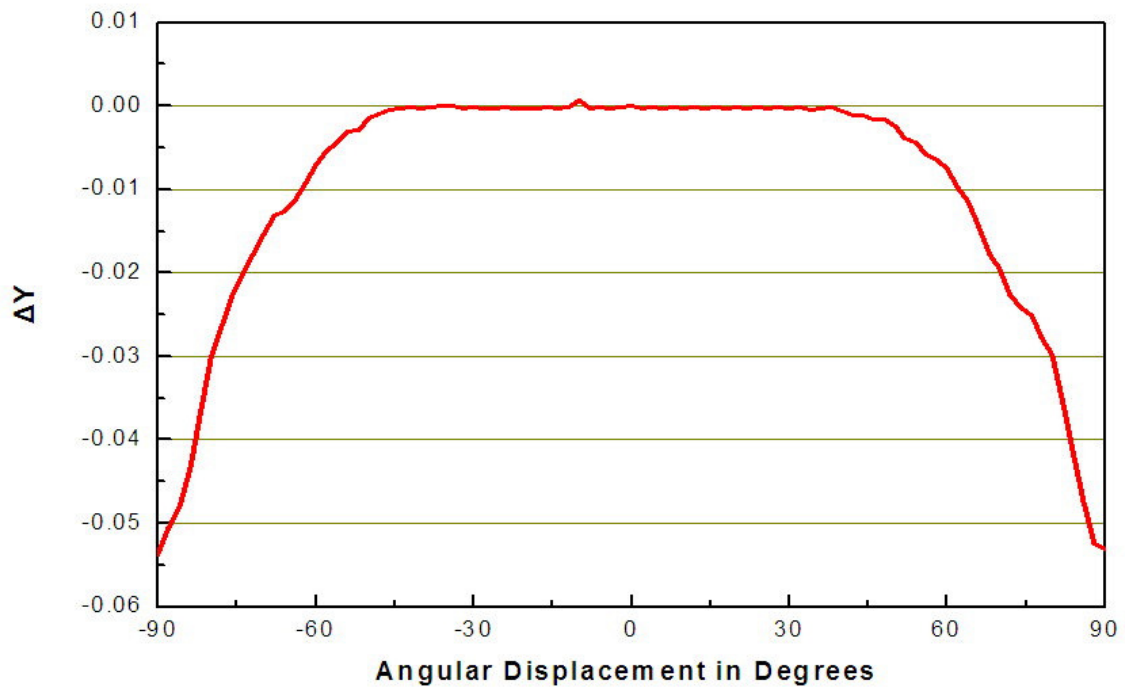

Emitter Tape Packaging

Carrier Tape Dimensions: Loaded quantity 400 PCS per reel

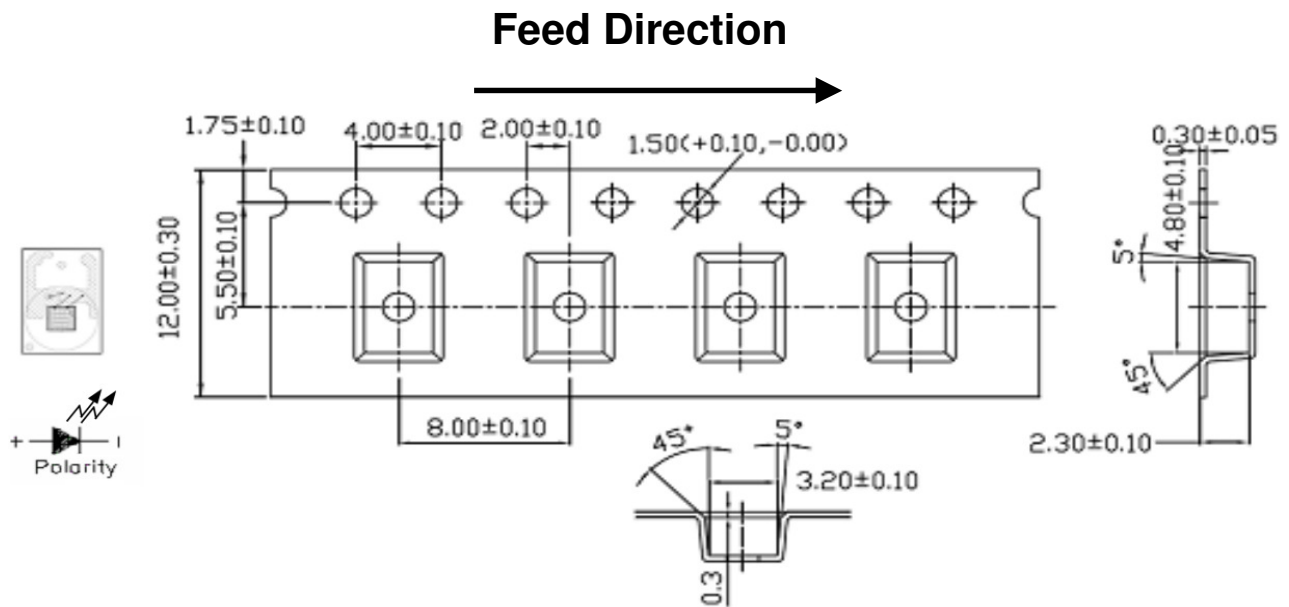

Notes.

1. Dimensions are in millimeters.
2. Tolerances for fixed dimensions are ± 0.1 mm.

Moisture Resistant Packaging

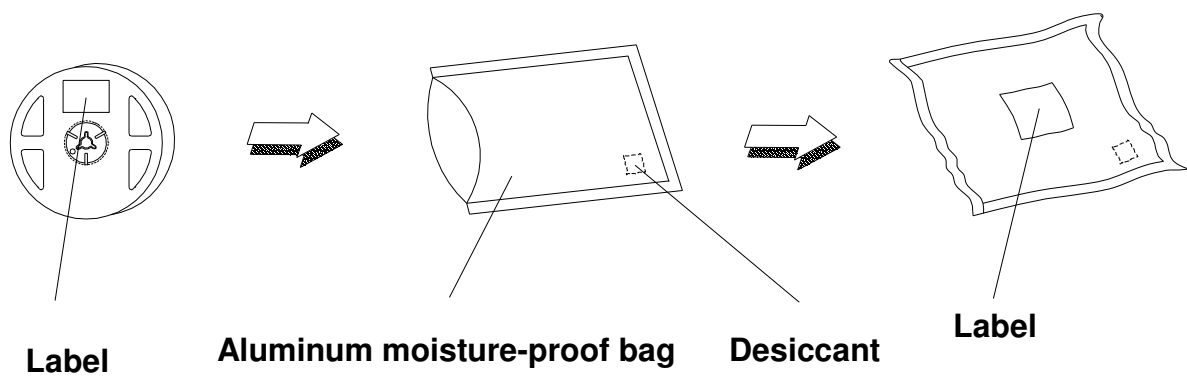

Emitter Reel Packaging

Reel Dimensions

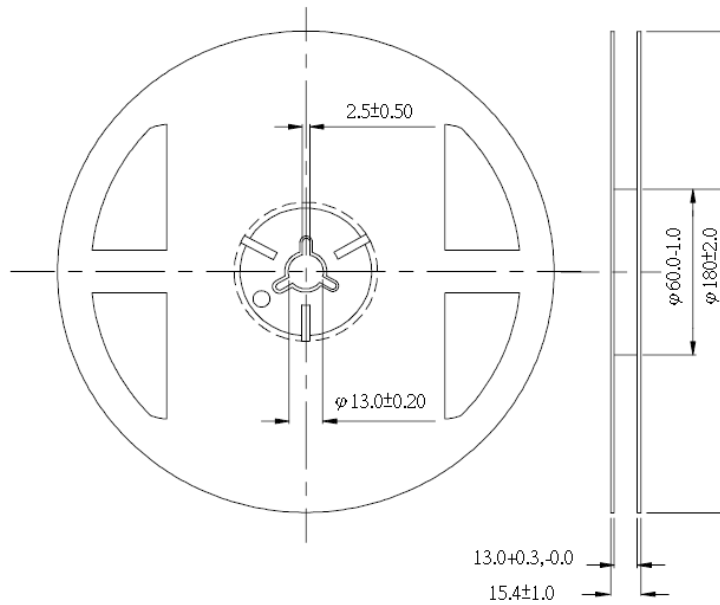

Notes :

1. Dimensions are in millimeters.
2. Tolerances unless mentioned are ± 0.1 mm.

Product Labeling

Label Explanation

CPN: Customer Specification (when required)

P/N : Everlight Production Number

QTY: Packing Quantity

CAT: Luminous Flux (Brightness) Bin

HUE: Color Bin

REF: Forward Voltage Bin

LOT No: Lot Number

MADE IN TAIWAN: Production Place



Revision History

Current version: **2009/08/31**
 Previous version: N/A

Device No. Preliminary
 Rev. 2.0

Page	Subjects (major change in previous version)	Date of change
P6	Add PN number that Everlight recommend	2009/08/25